

GRIPPEX

Powerful coolant driven bar puller and pick-up unit

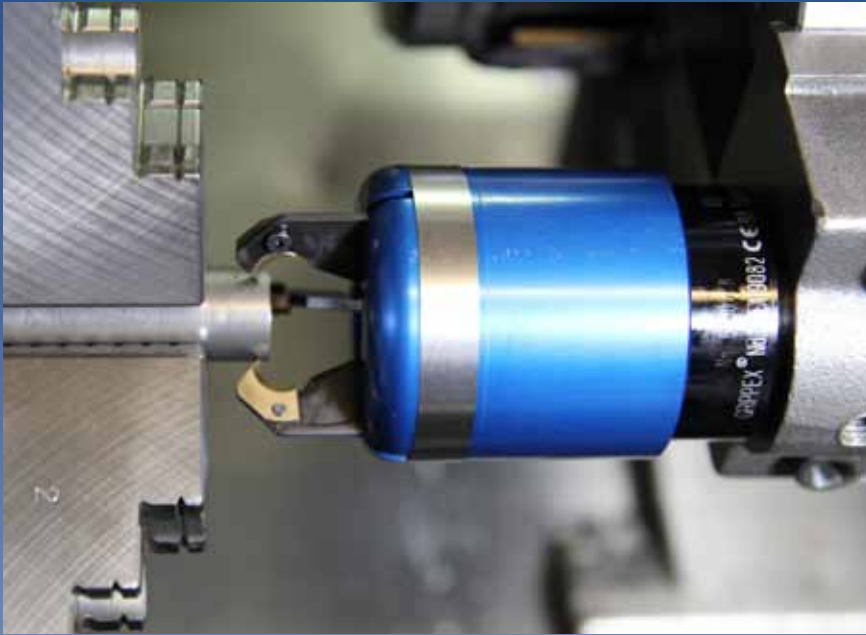

- Instant setup - gripping is secured without any adjustment within the whole gripping range
- Compact and light - Adjacent turret tool positions need not be empty
- Powerful - stands high pressure up to 20 bar
- Grippex doesn't need high pressure for pulling properly. It can work from 0,5 bar onward
- Clamps very close to the chuck, allowing short overhang of the bar
- Clamps hexagon bars without need for spindle orientation
- Can also be used as a pick-up unit with robot jaws

For various reasons, such a high costs or limited floor space in work shops, a small percentage of the CNC lathes are equipped with some kind of magazine-type bar feeder. In small-batch production, however, the machine spindle itself, in addition to its inserted guiding tube and Grippex, provides you with a simple and highly efficient bar feeder.

Grippex is the bar puller that makes your CNC lathe more effective right away!

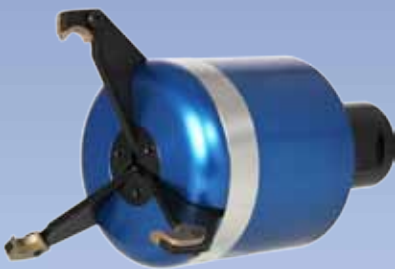

Grippex Large 2-60 mm
3-80 mm
7-105 mm



Grippex Small 2-52 mm



Grippex Mini 0-38 mm
(2 fingers model)

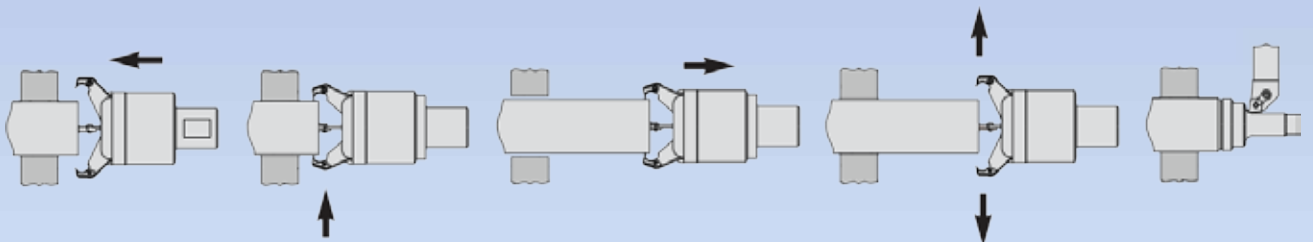

Grippex approaches bar to be pulled

Coolant **ON** for Grippex to clamp

Chuck unclamp, turret moves back along Z-axis and stops exactly at programmed position

Chuck clamp; coolant **OFF**. Grippex unclamp; turret retracts

Begin machining new part

Specifications

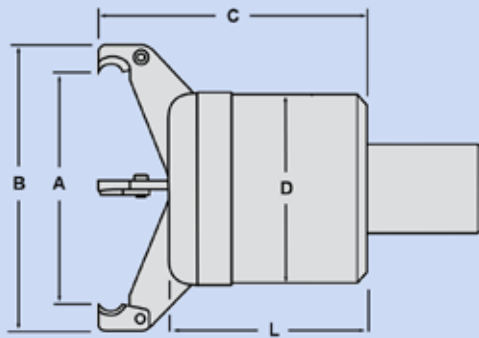

Gripping Range	A	B	C	D	L
Large 2-60 mm	64 mm	83 mm	89 mm	68 mm	71 mm
Large 3-80 mm	83 mm	102 mm	94 mm	68 mm	71 mm
Large 7-105 mm	110 mm	129 mm	108 mm	68 mm	71 mm
Small 2-52 mm	54 mm	74 mm	86 mm	59 mm	64 mm
Mini 0-38 gripping	39 mm	52 mm	61.5 mm	44 mm	49.50 mm
Mini 0-38 robot	40 mm	60 mm	70.5 mm	44 mm	49.50 mm

* VDI 20 for Mini and VDI 30 for Large the length L and C are + 11.80 mm
 * VDI 40 for Large the length L and C are + 12.80 mm

Pulling Force Graph

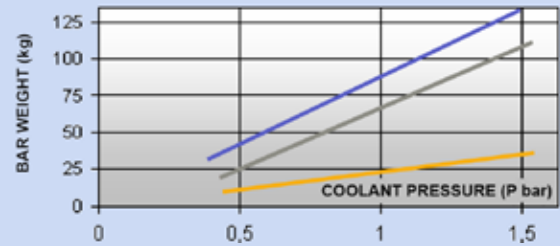

The graph shows the max. allowable weight of a mild steel bar to be pulled at a coefficient of friction valued <0.2

- - Grippex Large max pressure 20 bar
- - Grippex Small max pressure 15 bar
- - Grippex Mini max pressure 7 bar

Grippex Large

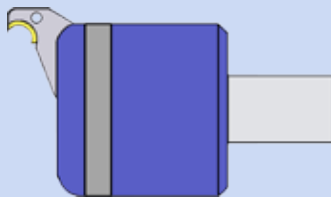

Shanks

- Straight $\varnothing 25$, $\varnothing 32$, $\varnothing 40$ mm
- VDI 30, VDI 40

Gripping fingers

- 2-60 mm
- 3-80 mm
- 7-105 mm

Inserts

- Gripping Inserts (IF)

Option Inserts

- Robot Inserts (RI)
- Robot Jaws (RJ) for 3-80 mm



Grippex Small

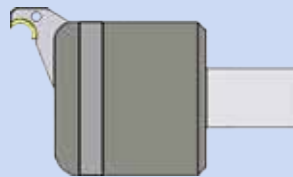

Shanks

- Straight $\varnothing 20$, $\varnothing 25$, $\varnothing 32$ mm
- VDI 20, VDI 30

Gripping fingers

- 2-52 mm

Inserts

- Gripping Inserts (IF)

Option Inserts

- Robot Inserts (RI)

Grippex Mini

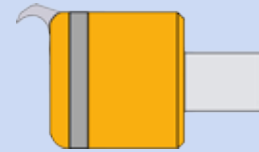

Shanks

- Straight $\varnothing 16$, $\varnothing 20$, $\varnothing 25$ mm
- VDI 16, VDI 20

Gripping fingers

- 0-38 mm (with gripping fingers)
- 0-38 mm (with robot fingers)

Option Inserts

- Robot Jaws (RJ-M) for robot fingers

For order codes and further accessories, please see the price list or visit www.barpuller.com

Distributed by:

MPC

MPC Automation Systems AB
 Box 5879, SE-102 40 Stockholm, Sweden
 Phone: +46 8 6670950 Fax +46 8 6670952

Visit us at <http://www.barpuller.com>

Grippex® is Patented. Grippex® is a registered trademark by MPC Automation System AB.

The specifications, illustrations, and descriptions in this brochure vary in different markets and are subject to change without notice.