

Redukční vložky pro nástroje s válcovou stopkou

Reduction bushes for boring bar holders

Reduzierbuchse für Bohrstangenhalter

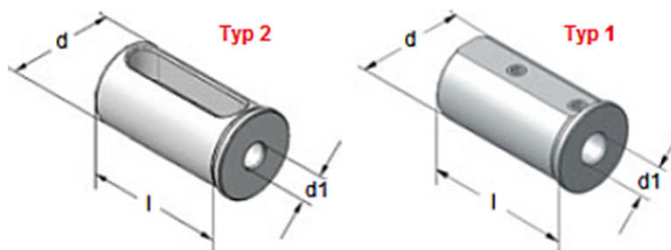

Objednací číslo Order no. Art.-Nr.	Typ		d	d1	l				
3002006	2		20	6	48				
3002008	2		20	8	48				
3002010	2		20	10	48				
3002012	2		20	12	48				
3002016	2		20	16	48				
3002506	1		25	6	50				
3002508	1		25	8	50				
3002510	2		25	10	50				
3002512	2		25	12	50				
3092514	2		25	14	50				
3002516	2		25	16	50				
3092518	2		25	18	50				
3002520	2		25	20	50				
3003206	1		32	6	60				
3003208	1		32	8	60				
3003210	1		32	10	60				
3003212	2		32	12	60				
3093214	2		32	14	60				
3003216	2		32	16	60				
3093218	2		32	18	60				
3003220	2		32	20	60				
3003225	2		32	25	60				
3004006	1		40	6	72				
3004008	1		40	8	72				
3004010	1		40	10	72				
3004012	1		40	12	72				
3094014	2		40	14	72				
3004016	2		40	16	72				
3094018	2		40	18	72				
3004020	2		40	20	72				
3004025	2		40	25	72				
3004032	2		40	32	72				
3005010	1		50	10	80				
3005012	1		50	12	80				
3005016	1		50	16	80				
3005020	2		50	20	80				
3005025	2		50	25	80				
3005032	2		50	32	80				
3005040	2		50	40	80				

Redukční vložky pro nástroje s válcovou stopkou

Reduction bushes for boring bar holders

Reduzierbuchse für Bohrstangenhalter

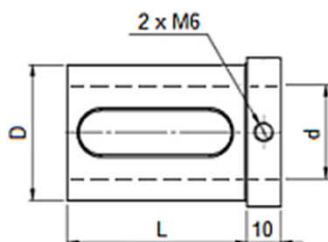

Objednací číslo Order no. Art.-Nr.	Typ		D	d	L				
9003220	2S		32	20	53				
9003225	2S		32	25	53				
9004020	2S		40	20	53				
9004025	2S		40	25	53				
9004032	2S		40	32	53				

Redukční vložky pro nástroje s válcovou stopkou

Reduction bushes for boring bar holders

Reduzierbuchse für Bohrstangenhalter

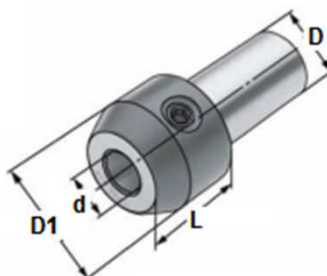

- hladká stopka

Objednací číslo Order no. Art.-Nr.	Typ		D h6	d H4	L	D1			
1222006			20	6	30	25			
1222008			20	8	30	28			
1222010			20	10	30	35			
1222012			20	12	35	42			
1223206			32	6	30	25			
1223208			32	8	30	28			
1223210			32	10	30	35			
1223212			32	12	35	42			
1223214			32	14	35	44			
1223216			32	16	38	48			
1223218			32	18	38	50			
1223220			32	20	40	52			

Redukční vložky pro nástroje s válcovou stopkou

Reduction bushes for boring bar holders

Reduzierbuchse für Bohrstangenhalter



Objednací číslo Order no. Art.-Nr.	Typ		d	d1	l				
6022006	7		20	6	55				
6022008	7		20	8	55				
6022010	7		20	10	55				
6022012	7		20	12	55				
6022014	7		20	14	55				
6022016	7		20	16	55				
6022506	7		25	6	65				
6022508	7		25	8	65				
6022510	7		25	10	65				
6022512	7		25	12	65				
6022514	7		25	14	65				
6022516	8		25	16	65				
6022518	8		25	18	65				
6022520	8		25	20	65				
6023206	7		32	6	70				
6023208	7		32	8	70				
6023210	7		32	10	70				
6023212	7		32	12	70				
6023214	7		32	14	70				
6023216	7		32	16	70				
6023220	8		32	20	70				
6023225	8		32	25	70				
6024006	7		40	6	80				
6024008	7		40	8	80				
6024010	7		40	10	80				
6024012	7		40	12	80				
6024014	7		40	14	80				
6024016	7		40	16	80				
6024020	7		40	20	80				
6024025	7		40	25	80				
6024032	8		40	32	80				

Redukční vložky pro nástroje s válcovou stopkou

Reduction bushes for boring bar holders

Reduzierbuchse für Bohrstangenhalter

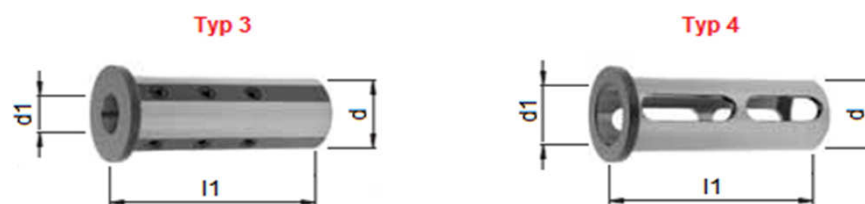

Objednací číslo Order no. Art.-Nr.	Typ		d	d1	l				
6003206	3		32	6	90				
6003208	3		32	8	90				
6003210	3		32	10	90				
6003212	3		32	12	90				
6003216	3		32	16	90				
6003220	3		32	20	90				
6003225	4		32	25	90				
6004006	3		40	6	110				
6004008	3		40	8	110				
6004010	3		40	10	110				
6004012	3		40	12	110				
6004016	3		40	16	110				
6004020	3		40	20	110				
6004025	3		40	25	110				
6004032	4		40	32	110				



Objednací číslo Order no. Art.-Nr.	Typ		d	d1	l				
6013208	5		32	8	70				
6013210	5		32	10	70				
6013212	5		32	12	70				
6013216	5		32	16	70				
6013220	5		32	20	70				
6013225	5		32	25	70				
6014008	5		40	8	80				
6014010	5		40	10	80				
6014012	5		40	12	80				
6014016	5		40	16	80				
6014020	5		40	20	80				
6014025	5		40	25	80				
6014032	5		40	32	80				

Redukční vložky pro nástroje s válcovou stopkou, rozříznutá

Reduction bushes for tools with straight-shank, slotted

Reduzierbuchse für Werkzeuge mit Zylinderschaft, geschlitzt

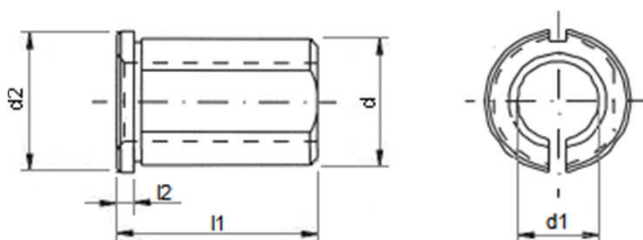

Objednací číslo Order no. Art.-Nr.			d	d1	d2	l1	l2		
5002008			20	8	24	50	4		
5002010			20	10	24	50	4		
5002012			20	12	24	50	4		
5002014			20	14	24	50	4		
5002015			20	15	24	50	4		
5002016			20	16	24	50	4		
5002508			25	8	29	50	4		
5002510			25	10	29	50	4		
5002512			25	12	29	50	4		
5002514			25	14	29	50	4		
5002515			25	15	29	50	4		
5002516			25	16	29	50	4		
5002518			25	18	29	50	4		
5002520			25	20	29	50	4		
5003208			32	8	36	60	4		
5003210			32	10	36	60	4		
5003212			32	12	36	60	4		
5003214			32	14	36	60	4		
5003215			32	15	36	60	4		
5003216			32	16	36	60	4		
5003218			32	18	36	60	4		
5003220			32	20	36	60	4		
5003225			32	25	36	60	4		
5004010			40	10	44	75	4		
5004012			40	12	44	75	4		
5004014			40	14	44	75	4		
5004015			40	15	44	75	4		
5004016			40	16	44	75	4		
5004018			40	18	44	75	4		
5004020			40	20	44	75	4		
5004025			40	25	44	75	4		
5004032			40	32	44	75	4		
5005020			50	20	54	75	4		
5005025			50	25	54	75	4		
5005032			50	32	54	75	4		
5005040			50	40	54	75	4		
5006025			60	25	64	75	4		
5006032			60	32	64	75	4		
5006040			60	40	64	75	4		
5006050			60	50	64	75	4		

Morse redukční vložky

Morse taper sleeve  
 Morse Reduzierhülse

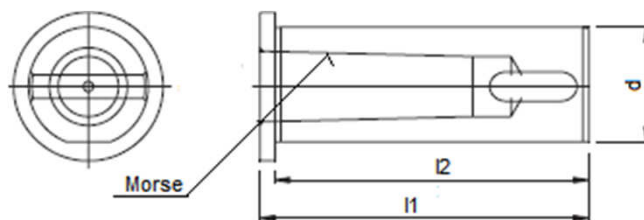

Objednací číslo Order no. Art.-Nr.		Morse	d	l1	l2				
6003201		1	32	90	85				
6003202		2	32	90	85				
6003203		3	32	100	95				
6004002		2	40	110	105				
6004003		3	40	110	105				
6004004		4	40	135	130				
6105002		2	50	130	125				
6105003		3	50	130	125				
6105004		4	50	130	125				
6106003		3	60	140	130				
6106004		4	60	140	130				
6106005		5	60	155	145				

**Upínací pouzdra pro závitníky pro upnutí do Weldonu**

Clamping sleeves for taps

Gewindebohrer-Spannhülsen

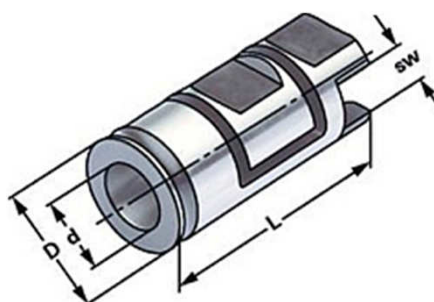

- pružné (rozřezané) pouzdro pro pevné uchycení závitníku ve Weldonu, konec pouzdra je opatřen čtyřhranem
- pro stroje se synchronně řízeným vřetenem

Objednací číslo Order no. Art.-Nr.	Označení	D	d	sw	L			
50408025	GE 8 - 2,5 x 2,1	8	2,5	2,1	36			
50408028	GE 8 - 2,8 x 2,1	8	2,8	2,1	36			
50410035	GE 10 - 3,5 x 2,7	10	3,5	2,7	40			
50410040	GE 10 - 4,0 x 3,0	10	4	3	40			
50410045	GE 10 - 4,5 x 3,4	10	4,5	3,4	40			
50412060	GE 12 - 6,0 x 4,9	12	6	4,9	45			
50414070	GE 14 - 7,0 x 5,5	14	7	5,5	45			
50414080	GE 14 - 8,0 x 6,2	14	8	6,2	48			
50416090	GE 16 - 9,0 x 7,0	16	9	7	48			
50416100	GE 16 - 10,0 x 8,0	16	10	8	48			
50418110	GE 18 - 11,0 x 9,0	18	11	9	50			
50420120	GE 20 - 12,0 x 9,0	20	12	9	50			
50425140	GE 25 - 14,0 x 11,0	25	14	11	56			
50425160	GE 25 - 16,0 x 12,0	25	16	12	56			
50432180	GE 32 - 18,0 x 14,5	32	18	14,5	60			
50432200	GE 32 - 20,0 x 16,0	32	20	16	60			
50432220	GE 32 - 22,0 x 18,0	32	22	18	60			
50440250	GE 40 - 25,0 x 20,0	40	25	20	70			
50440280	GE 40 - 28,0 x 22,0	40	28	22	70			
50450320	GE 50 - 32,0 x 24,0	50	32	24	81			
50450360	GE 50 - 36,0 x 29,0	50	36	29	81			
50450400	GE 50 - 40,0 x 32,0	50	40	32	81			

**Upínací pouzdra s rychlovýměnnou spojkou pro upnutí závitníků do Weldonu**

Clamping sleeves for taps with quick change adaptor

Gewindebohrer-Spannhülsen mit Schnellwechselkuplung

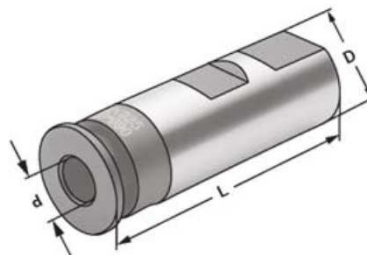

- pouzdro pro upnutí závitníku ve Weldonu s možností rychlé výměny nástroje díky rychlovýměnné spojkě
- pro stroje se synchronně řízeným vřetenem

Objednací číslo Order no. Art.-Nr.	Označení	D	d	sw	L			
37616035	GES 16 - 3,5 x 2,7	16	3,5	2,7	56			
37616040	GES 16 - 4,0 x 3,0	16	4,0	3,0	56			
37616045	GES 16 - 4,5 x 3,4	16	4,5	3,4	56			
37616060	GES 16 - 6,0 x 4,9	16	6,0	4,9	56			
37620450	GES 20 - 4,5 x 3,4	20	4,5	3,4	58			
37620060	GES 20 - 6,0 x 4,9	20	6,0	4,9	58			
37620070	GES 20 - 7,0 x 5,5	20	7,0	5,5	58			
37620080	GES 20 - 8,0 x 6,2	20	8,0	6,2	58			
37620090	GES 20 - 9,0 x 7,0	20	9,0	7,0	58			
37620100	GES 20 - 10,0 x 8,0	20	10,0	8,0	58			
37625045	GES 25 - 4,5 x 3,4	25	4,5	3,4	66			
37625060	GES 25 - 6,0 x 4,9	25	6,0	4,9	66			
37625070	GES 25 - 7,0 x 5,5	25	7,0	5,5	66			
37625080	GES 25 - 8,0 x 6,2	25	8,0	6,2	66			
37625090	GES 25 - 9,0 x 7,0	25	9,0	7,0	66			
37625100	GES 25 - 10,0 x 8,0	25	10,0	8,0	66			
37625110	GES 25 - 11,0 x 9,0	25	11,0	9,0	66			
37625120	GES 25 - 12,0 x 9,0	25	12,0	9,0	66			
37632060	GES 32 - 6,0 x 4,9	32	6,0	4,9	70			
37632070	GES 32 - 7,0 x 5,5	32	7,0	5,5	70			
37632080	GES 32 - 8,0 x 6,2	32	8,0	6,2	70			
37632090	GES 32 - 9,0 x 7,0	32	9,0	7,0	70			
37632100	GES 32 - 10,0 x 8,0	32	10,0	8,0	70			
37632110	GES 32 - 11,0 x 9,0	32	11,0	9,0	70			
37632120	GES 32 - 12,0 x 9,0	32	12,0	9,0	70			
37632140	GES 32 - 14,0 x 11,0	32	14,0	11,0	70			
37632160	GES 32 - 16,0 x 12,0	32	16,0	12,0	70			
37632180	GES 32 - 18,0 x 14,5	32	18,0	14,5	70			